

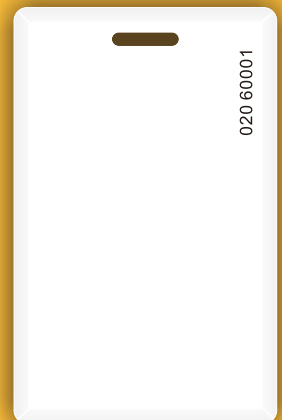

## Access Badges for mainstream Access Control Systems



## Transponders & Credentials

- ▲ 10 days delivery
- ▲ Budget-friendly
- ▲ Print logo available

Nubian International Ltd  
sales@nubian-rfid.com  
www.nubian-rfid.com

# NubianRFID RFID BADGES

Economically Versatile Solution for Physical Access Control

## Access Badge Options

- Clamshell Card
- ISO Printable PVC Card
- Plastic/ Epoxy Key Fobs
- Sticker Tags
- Wristbands



## 125kHz Exclusive Proximity Chip Support:

<b>Keri</b>	<b>AWID</b>	<b>RBH50</b>	<b>Kastle</b>
<b>Indala</b>	<b>Keyscan</b>	<b>AMAG</b>	<b>Indentiv</b>
<b>KANTECH ioProx</b>	<b>HID Prox</b>	<b>Casi-Rusco</b>	<b>GE Security</b>
<b>NexWatch Quadrakey</b>	<b>Honeywell OmniProx</b>	<b>FarPointe Pyramid</b>	<b>Lenel32 / Interlogix</b>

Wiegand format 26, 32, 34, 36, 37, 40, 50 bit formats are fully supported by NubianRFID. Please contact sales to check if your key card brand's format is supported. NubianRFID continuously expands the support list.

## 13.56MHz Hotel Room Card Support:

<b>VingCard</b>	<b>SALTO</b>	<b>KERI</b>	<b>MIWALock</b>	<b>ACCULock</b>
<b>BONWIN</b>	<b>BETECH</b>	<b>TSS</b>	<b>Level/Kale</b>	<b>HAFELEA</b>
<b>LOCCA</b>	<b>ORBITA</b>	<b>YGS</b>	<b>WOLFER</b>	<b>EM-MARIN</b>

- |                    |                         |
|--------------------|-------------------------|
| DURABLE            | LOGO PRINTING           |
| COST-EFFECTIVE     | 10 DAYS DELIVERY        |
| LIFE TIME WARRANTY | RELIABILITY PERFORMANCE |

# ISO Printable Multi-protocol Chips Card Selection Guide

Exclusive Proximity Card



EM/TK Proximity Card

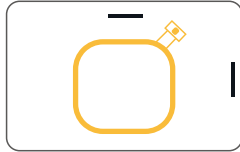

EM+Exclusive Proximity Card

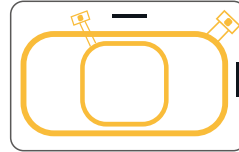

Triple Protocols

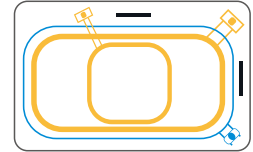

Contactless High Frequency Card



Exclusive+HF Dual-chips Card

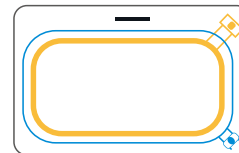

EM+HF Dual-chips Card

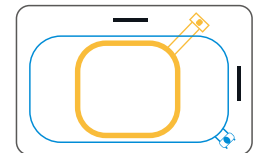

Contactless Ultra high frequency Card

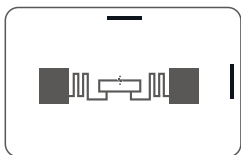

Exclusive+UHF Dual-chips Card

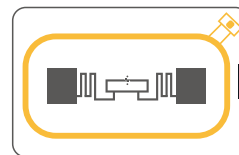

HF+UHF Dual-chips Card

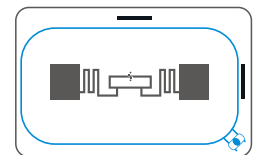

125kHz Exclusive proximity antenna and chip



125kHz EM4100/TK4100 antenna and chip



13.56 MHz MIFARE contactless antenna and chip



Durable PVC thin card with vertical or horizontal slot punch and high quality printing surface for photo ID and barcode. (ISO 7816 and 7810 compliant).



860~960MHz ALN-9662 antenna and chip

All NubianRFID-ISO cards have a lifetime warranty. NubianRFID continuously expands its list of product lines. Please contact your sales representative to verify if your inquiry product is currently supported.



NK01-FR4



NK01-ABS



NK02



NK03



NK04



NK05



NK06



NK07



NK08



NK9



NK10



Nk11



NS01  
Oval head



NS02  
Round head



NS03



NS06



NS07  
adjustable



NS08  
Adjustable Buckle



NS10  
Dual Frequency



NS11  
Dual Frequency



NS16  
915MHz UHF



NS17  
Slap Bracelet



NW01 RFID



NW02 RFID



NW04 RFID



NW05 RFID



NW07 RFID



NW08 RFID



NF01 Single-Use  
Fabric



NF03 Elastic  
Fabric

As brochure space limited, there are dozens of products didn't put in. NubianRFID has other different shapes, and different materials of sticker tags, key fobs, and wristbands. Contact sales, and we will assist you to get the products you need.

NubianRFID one time use wristbands have paper and waterproof PVC material. Available for low frequency, high frequency and ultra high frequency. Supported offset printing, QR/BR Code, laser engrave artwork.

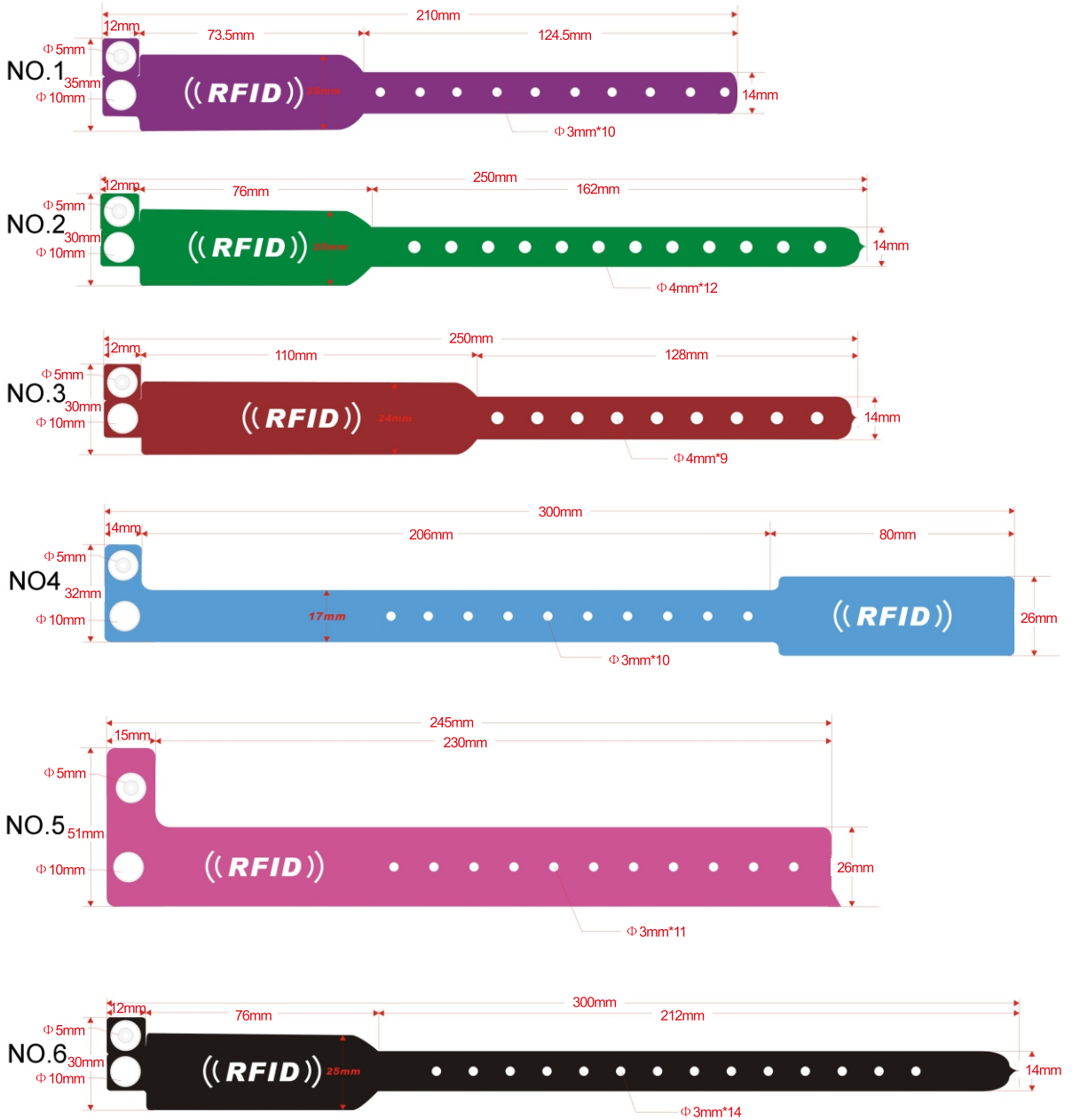

NubianRFID continuously expands its list of product lines. Please contact your sales representative to verify if your inquiry product is currently supported.



**NUBIAN INTERNATIONAL RFID PRODUCT CUSTOMIZATION  
AND MANUFACTURING. PROVIDING PVC CARDS,  
RFID CONTACTLESS CARDS, RFID TOKEN, RFID WRISTBANDS,  
RFID KEY FOB, TAGS & LABELS AND RFID ANTENNA CUSTOMIZATION.**

**OUR MISSION IS TO OFFER  
HIGHLY COMPETITIVE WORLDWIDE PRICING BACKED UP WITH  
EXEMPLARY QUALITY AND SERVICE THAT IS UNRIVALLED IN THE RFID INDUSTRY.**

**WE OFFER CLIENTS THE ABILITY TO HARNESS  
THE LOW-COST PRODUCTION BASE OF ASIA WITHOUT  
BEING SUBJECTED TO THE QUALITY AND RELIABILITY  
RISKS INHERENT TO DOING BUSINESS IN THIS REGION.  
AS AN EXPERIENCED RFID SUPPLIER,  
WE ENSURE THE HIGHEST WESTERN STANDARDS OF QUALITY  
AND SERVICE AND STAND BEHIND OUR PRODUCTS 100%.**

**NUBIAN INTERNATIONAL LTD  
[www.nubian-rfid.com](http://www.nubian-rfid.com)**

**Flat J, 4/F  
HOUSTON INDUSTRIAL BUILDING  
32 WANG LUNG ST  
TSUEN WAN, NT, HONG KONG**